LU-R/C1000

LU R/C1000

U

" LU R1000" " LU C1000" 1



U

2G 4G

LU-R/C1000

LU-R/C1000

2 P I D

2

4

P I D

P I D

100

140

5600

USB

FLASH

U

PAD

/

RS232

- V -

U
MGS

RS485

LU-R/C1000

LU-R/C1000	V
	VII
	1
1.1	1
1.2	2
1.3	5
1.3.1	5
1.3.2	6
1.4	8
1.4.1	8
1.4.2	8

1.4.3	9
1.4.4	14
1.5	15
1.5.1	15
1.5.2	15
1.5.3	17
1.5.4	19
	20
2.1	20
2.2	20
2.3	21
2.4	23
2.5	24
2.6	31

2 7	33
2 8	35
2 9	38
2 10	40
2.10.1	40
2.10.2	42
2 11	42
	43
3 1	43
3 2	45
3.2.1	46
3.2.2	47
3.2.3	49
3.2.4	51

3.2.5	/	54
3.3		56
3.3.1	901M 906M 960M	59
3.3.2	50M	64
3.3.3		68
3.3.4		69
3.3.4.1		69
3.3.4.2	PID	70
3.3.4.3		73
3.3.4.4		73
3.3.5		74
3.3.6		76
3.3.7		83
U		85

4.1		85
4.2	FLASH	86
4.3	U	86
4.4	U	87
		90
5.1	RS-232	90
5.2	RS-485	91
		94

1.1

LU-R/C1000

LCD

U

U

U

FAT

4

1.2

LU-R/C1000

0 45

85

1.2

50mm

LCD

LCD

()

1.2 1(D) 1.2 2 A

D 型：仪表尺寸 160×80×114mm



D 型：开口尺寸：152×76mm

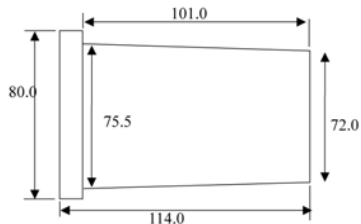
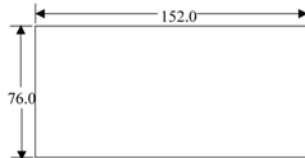

1.2.1 D

A 型：仪表尺寸 96.0×96.0×105.0mm



A 型：开口尺寸：92.0×92.0mm

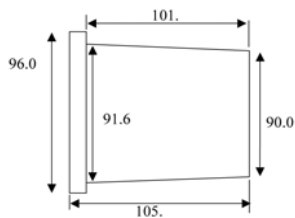
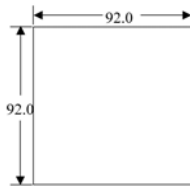

1.2.2 A

1.3

1.3.1



1.3.1.1 LU-R/C1000

1.3.1.1

LCD 128*64

:

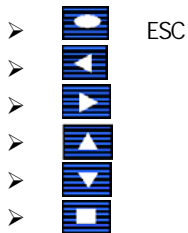

1.3.2



1.3.2.1 D

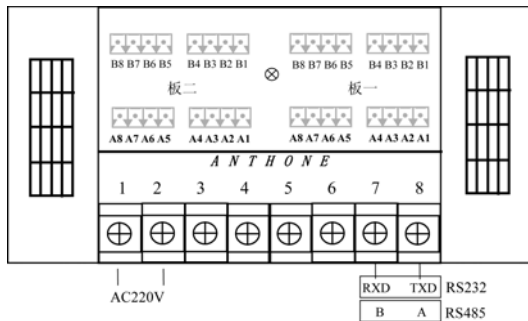

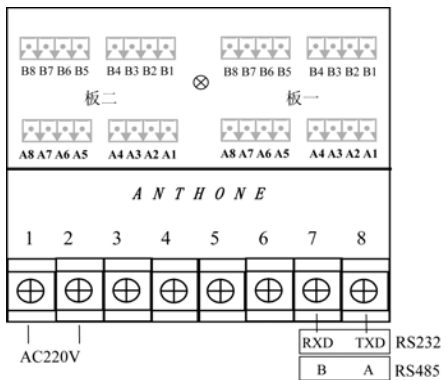

1. 3. 2. 2 A

1. 3. 2. 1

1. 4

1 2

B1 B8

A1 A8

1.4

:

1.4.1

12W 50Hz± 1Hz

1.3.2.1 1 2

220V

85-264VAC

1.3.2.1

RS232 7

PC 9

3

8

PC 9

2

B1

PC 9

5

RS485

7

B

8

A

1.4.2

0.5mm

1.4.3

901M 906M 960M 50M

901M

906M

PI D

960M

PI D

50M

1.5

1. 4. 3. 1

1. 4. 3. 2

LU-R/C1000

PI D

906M 960M 50M

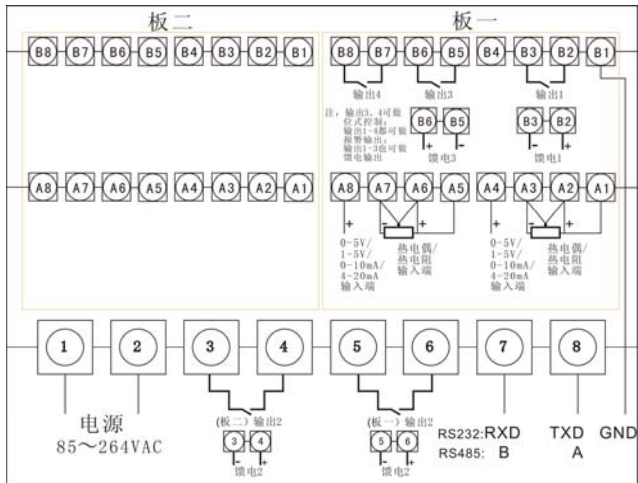

1. 4. 3. 1

901M

	901M	A1	A4	
A5	A8			" A3
A4	A7	A8	"	0-5V 1-5V 0-10mA
4-20mA				
250				
1	3	4		1 2
	3			

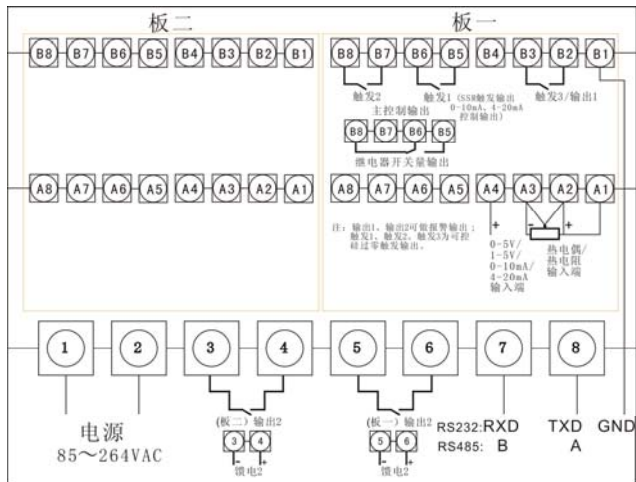

1. 4. 3. 2

906M 960M

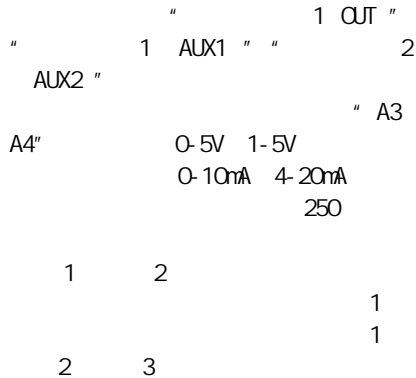

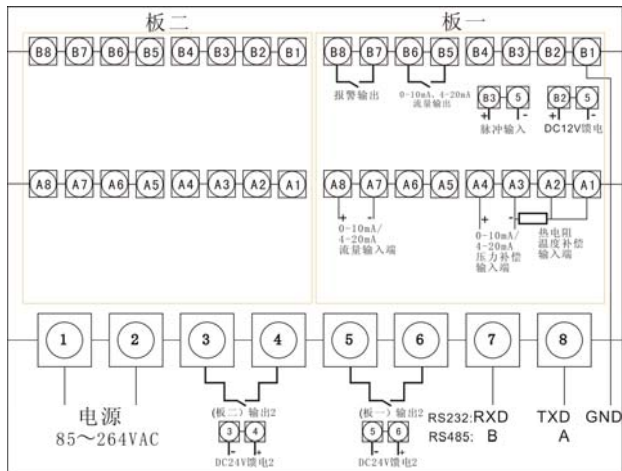

1. 4. 3. 3 50M

A1 A2 A3 Pt100 A3 A4
A7 A8
B5 B6
B3 5
B3 3
B2 5 +12VDC/50mA
B2 3 +12VDC/50mA
3 4 5 6 +24VDC/50mA
B7 B8
B2 6 A7 5
A8
A3 5 B2 6
A4

1. 4. 4

1. 3. 2. 1 , ,

A1-A8 , B1-B8

1~8 1 2 220 3 4 2 5 6 2

7 8

1. 4. 3. 1 1. 4. 3. 2 1. 4. 3. 3

1. 4. 4

1.5

1.5.1

0.5
: ± 0.2 F.S
 ± 0.2 F.S
 ± 0.2 F.S
 ± 0.2 F.S
 ± 0.2 F.S
85-264VAC 12W 50Hz \pm Hz

1.5.2

LU-R/C1000

400V

0~10mA DC 4~20mA DC 0~5VDC 1~5VDC

B E J K S T W e325 N

Pt100 Cu50 Cu100

	0~10mADC	0~5VDC
	4~20mADC	1~5VDC
K	0	~1300
S	0	~1700
B	0	~1800
T	-200	~400
E	-200	~1000
J	0	~800
We325	0	~2300
N	0	~1300
Pt100	-200	~600
Cu50	-50	~150
Cu100	-50	~150

2V 0-6.5KHz 0-10mADC 4-20mADC, 0-5V, 1-5V
 0-10mADC 4-20mADC

250

650K

<10

1

4

± 1

1.5.3

1

- ◆ 0-10mADC (R.<1000 2000)
- ◆ 0-20mADC (R.<500 1000)
- ◆ 0-22mADC ()
- ◆ 12V/50mADC

- ◆
- ◆ ()
- ◆ 24V <200mA DC

2

- ◆ I1 901
- ◆ I2 Q. 2% F. S 901
- ◆ V5 / Q. 2% F. S 901
- ◆ T SSR 12V/50mA 901
- ◆ T1 800A
- ◆ 901
- ◆ T2 800A
- ◆ 901
- ◆ J1 3A/220V /
- ◆ J2 Q. 8A/220V

- ◆ V1 12V/50mAADC
- ◆ V2 24V/50mAADC
- ◆ V3 5V/50mAADC

3

0-10mA 4-20mA

1.5.4

FLASH 4000KB,
140 5600

2 1

LU-R/C1000

2 2



2 2 LU-R/C1000

10

2 2

ESC

5

1

2

" _ _ _ ' _ _ _ "

" _ _ _ ' _ _ _ "

2 3

Flash Error
Clock Error
BATTER Error

2 3 LU-R/C1000

2 3

FLASH FLASH ERROR FLASH
CLK 1. CLK ERROR
 2. BATTER ERROR

2 4

CH1:0001K CH2:0003K CH3:0006K CH4:0008K Unused:4014K	U Disk 1000 M
--	------------------------

2 4

CH (U Di sk) (4)
U 2G 4G U " 0"
4 FLASH
(Unused) FLASH FLASH 4MB

2 5

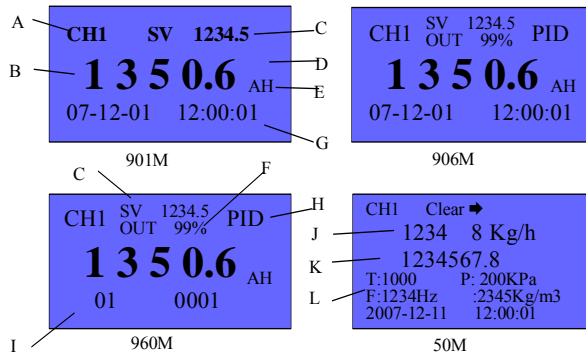

2 5 1

PID
SV 1234.5

906

PID
01
0012

960

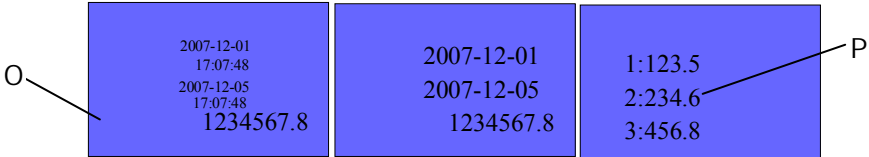

2 5. 2

901M

906M

960M

50M

A.

B.

C.

D.

E.

AH() AL Adel

F.

G.

" - - : : "

H.

PI D

I.

"

"

(960M)

J. 50M

0-19999

K. 50M

0-99999999

L.

M

0 0

()

N

23 59

()

O

P.

1			ESC			
2			906M	960M		◀/▶
3			960M			◀/▶
4		▲/▼				
5		906	960		<u>2 5.2</u>	◀/▶
			▲/▼			960M
	906M		ESC			
6		50M			"	"
						2 8

7

ESC

A 901M

B 906M

1

PI D

2 5.1
◀/▶

▲/▼

2

▲/▼

2 5.1 ▶/◀
ESC

C 960M

1

PI D

906M

2

2 5 1

◀/▶

▲/▼

ESC

3

◀/▶

"

"

◀

"

"

D 50M

1

2 5 2 ;

2

▲/▼

26

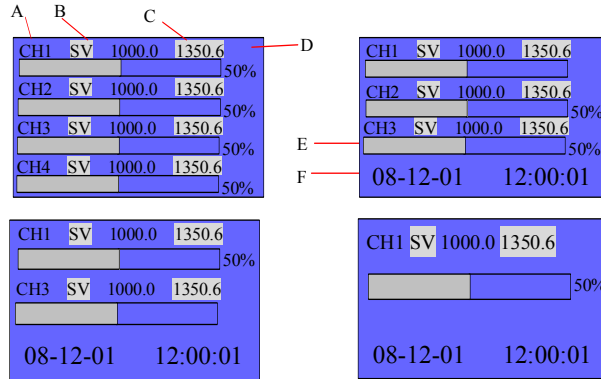

26 4

4

26

A.

B. SV

C.

D. :

E. : ,

F. " - - : : " (4 ,)

1 ESC

27

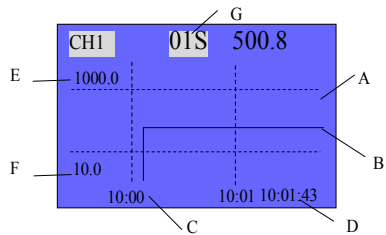

27 LU-R/C1000

A.

B.

C.

D.

E.

F.

G.

" - - " " "

100% ()

0% ()

10 ◀/▶

1

1

ESC

2

2 8

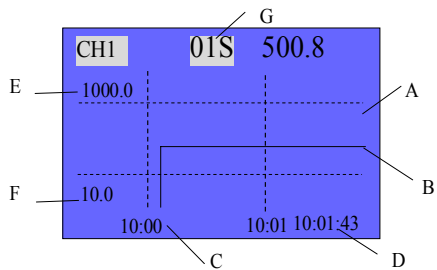

2 8 1

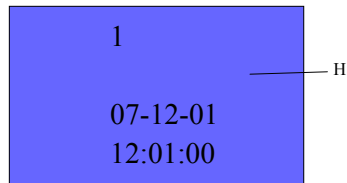

2 8 2

A

, " "

B

C

D

, " - - " " : " ,

E

:

100% ()

F

0% ()

G

1 15

▲/▼

H

1

ESC

2

,

8

3

▲/▼

▼

4

/

▲

◀/▶

/

8

◀/▶

/

5

◀/▶

ESC

29

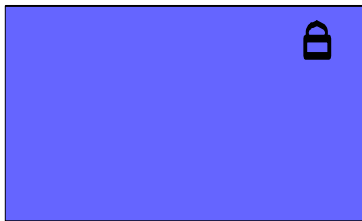

29

(3.1)

(3.2)

- 38 -



2 10

001	1	07-01-01 08:00:00	HiA
002	3	07-01-01 08:00:10	LoA

:			
:			HiA
:		07-01-01 08:00	
:		07-01-02 08:00	

2 10

2 10 1

2

500

U

1 2...500

1-4

" - - : : "

" - - : : "

" -"

1

1

ECS

2

▲/▼

3

3 2 3

" "

4

ESC

U

2 10 2

2 11 _____

U

ECS

U

PC

U

2GU

FAT

4GU

FAT32

U

" U

"

U

U

U

U

U

U

U

"

..."

U

U

U

U

3 1

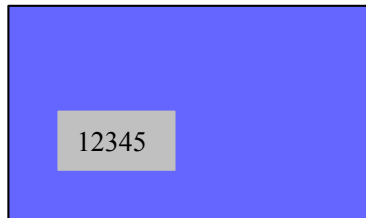

3 1

0~10

0~9 10

1

2



ESC

3

3.2

3.2

1/3 2007-05-22 10 25 35	2/3 001 9600	3/3
-------------------------------	--------------------	-----

3.2

3.2.1

" "

" "

RS-485

0-255

0

U

(LU2100 LU3000 LU5000)

1200 2400 4800 9600 19200

" bps

" "

3.2.4

FLASH

3.2.2

A)



B)

▲/▼

C)

▲/▼

◀/▶

0~10 0~9

▲/▼

D)

▲/▼

0-99

E)

▲/▼

▲/▼

1200 2400 4800 9600 19200

F)

▲/▼

3.23

G)

H)

3.25

3 2 3

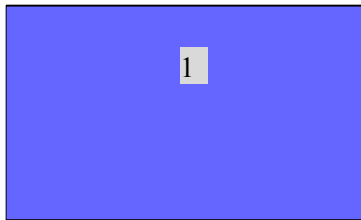

3 3

1-4

1-4

FLASH

&

1

2

3

▲/▼

ESC

▲/▼

"

&

"

3

"

"

◀/▶

"

"

"

"

ESC

"

"

1

1

"

"

2

3 2 4

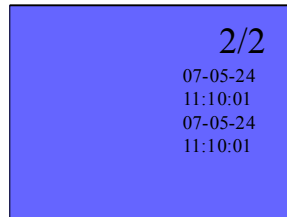
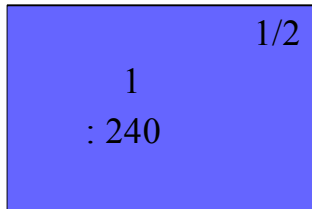

2 14

RS-232

" - - "

" - - "

<

1S 2S 5S 10S 15S 30S 60S 120S 180S 240S

1

2

ESC

▲/▼

3

▲/▼

◀/▶

ESC

	2								
4								"	..."
1									
2		RS-232C				7	RXD	8	TXD B1 GND
		TXD	RXD	GND					
3					9600				

3.2.5

/

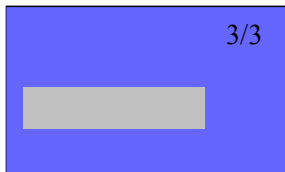

3.2.5.1



3.2.5.2

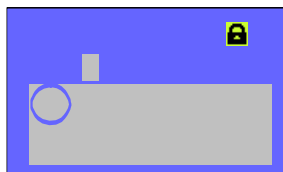

3.2.5.3

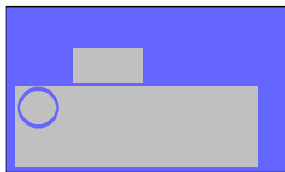

3.2.5.4

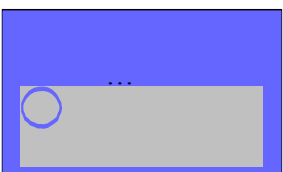

3.2.5.5

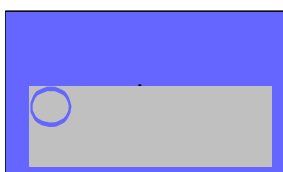

3.2.5.6

/

3.2.5.1 3.2.5.2

3.2.5.3 3.2.5.4 3.2.5.5 3.2.5.6

1 /

3.2.5.1 ESC

2

3.2.5.3

3.2

3.2.5.4 ◀/▶ /

3.2.5.1

3.2.5.5

3.2.5.6

2S

3.2.5.1

3.3

901	1/7
001	
K	

901	2/7
200.0	
200.0	
100.0	

901	3/7
0.0	
10.0	
0	

901	4/7
0.1	

901	5/7
-----	-----

901	6/7
150.0	
50.0	
20.0	

901	7/7
200.0	
10.0	

3.3.1

1(901)

906 1/10
001
K

906 2/10
200.0
10.0
100.0

906 3/10
0.0
20.0
0

906 4/10
0.1

906 5/10

906 6/10
150.0
100.0
20.0

906 7/10
4-20mA
mA 20.0
mA 4.0

906 8/10
50
PI D

906 9/10
PI D1 2000
PI D2 200
RT 20

906 10/10
200.0
10.0

3.3.2

1(906)

960 1/10
001
K

960 2/10
200.0
10.0

960 3/10
0.0
10.0
0

960 4/10
0.1
:
50

960 5/10

960 6/10
150.0
100.0
200.0

960 7/10
4-20mA
20.0
4.0

960 8/10
50
PI D

960 9/10
PI D1 2000
PI D2 200
RT 100

960 10/10
200.0
10.0

3 3 3

2(960)

3.3.1 901M 906M 960M

1. (1 4 4 , 906M 960M)
2. " XXXXX"
3. FLASH 1~240
4. 0~10mADC 0~5VDC 1~5VDC 4~20mADC B
E J K S T We325 N Pt100 Cu50 Cu100
5. % m³/h Km³/h Kg/h t/h r/min KPa MPa Pa mm PH
Hz KHz mA A KA mV V KV W KW kWh V.A KV.A mL L g Kg L/S ppm ,
6. , 19999

7.

, -9999

8

-9999~19999

"

"

9.

-9999~19999

10

0~255

11.

0

0~100

12

0.001

(0.01)

(0.1)

(0)

13

14.

15.

16.			100%		
17.			0%		
18.					<u>3.3.5</u>
19.		960M		5	100
					<u>3.3.6</u>
20.			0-100		
21.		FREE			0-10nA
					4-20nA
22.		FREE	FREE	"	& "
	0-25.0	nA			

23. FREE " & "
- 0~25.0 mA
24. 0~255
- 25.
26. P I D P I D
- P I D
27. P I D1 P I D 0~9999
28. P I D2 P I D 0~9999
29. RT 0~9999

50 1/10
001
100
10

50 2/10
: Fr
: K
4-20mA

50 3/10
: 200.0
: 10.0
: M

50 4/10
210
10
KPa

50 5/10
0.1
0.1
0.1

50 6/10
4-20mA
20.0
4.0

50 7/10
123456.0
150.0
100.0

50 8/10
50
100
50

50 9/10
PALM 200.0
()

50 10/10
200.0
10.0

3.3.4 50M

3.3.2 50M

1. (1 3,50M ,)
2. " XXXXX"
3. FLASH 1~240
4. K 0-9999 =K*KP m³/h Km³/h
5. KP ,
 10^{-3} /m³ 10^{-2} /m² 10^{-1} /m¹ 1 /m³ 10 /m³ 100 /m³
6. 2V , 0-6.5KHz 0-10mA 4-20mA 0-5V 1-5V
7. PT100 K E J T 0-10mA 4-20mA
8. 0-10mA 4-20mA
9. 0-19999 10mA 20mA,
 0-10mA 4-20mA , 10mA 20mA ,
 m³/h, " "

10. 0-19999 (0mA, 4mA),
 0-10mA 4-20mA (0mA 4mA)
11. m³/h, km³/h 1 /m³ = m³/h 1 /m³ = km³/h
12. KPa 0-9999KPa 10KPa, 10KPa,
 0-9999(0.00MPa-99.99MPa).
13. KPa 0-9999KPa 10KPa 10KPa
 0-9999(0.00MPa-99.99MPa)
14. KPa MPa KPa MPa
15. 0.001
16. 0.001
17. : 0.001

18.

0-10mA 4-20mA

19.

" "

20.

" "

21.

PALM

LU50 LU50K

22.

23.

24.

Hz

" 0"

0-10mA

4-20mA

" 0"

25.

26.

20

27. PALM

28. PALM(_____)

29. PALM(_____)

0

30. PALM(_____)

31.

, 1

2

3

4

5

6

32

100%

33

0%

34.
35.
3.3.3
1

▲/▼

2

▲/▼/◀/▶

ESC

3

▲/▼/◀/▶

4

3.3.7

3.3.5

▲/▼



ESC

3

3

3.3.4

901M

906M

PI D

960M

PI D

3.3.6

3.3.4.1

0

0.5

906M

960M

1 906M

960M

2

0.5

" 0"

3

PID



oN/oFF

,

3.3.4.2

PI D

1

PI D1

PI D1

PI D1

PI D1

PI D2

PI D2

RT
2

RT ,

RT ,

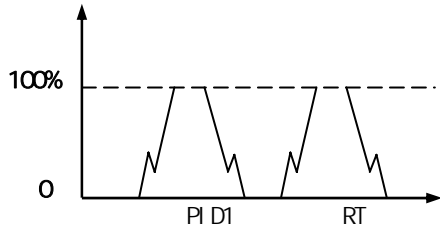

3. 3. 4. 1

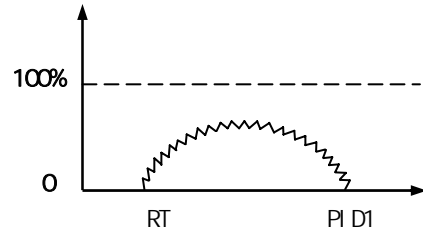

3. 3. 4. 2

PI D1 PI D2 RT

2 1

1,

2 2 , PI D1 RT PI D1
 :
 ● , RT PI D1
 ● PI D1 PI D2 RT
 PI D1=2000 PI D2=200 RT=100
 ● , 3. 3. 4. 1 PI D1 2000 1000, RT
 100 200, 3. 3. 4. 2, PI D1 1000-2000 , RT
 100-200
 ● PI D , PI D1 , PI D1 ,

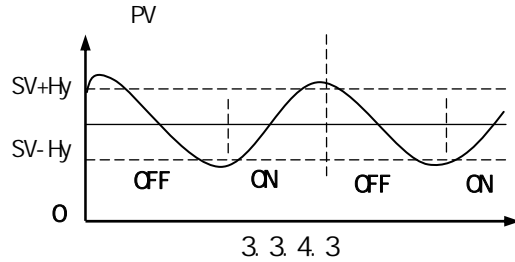

3 3 4 3

3. 3. 4. 3

SV

Hy

3 3 4 4

3 3 5

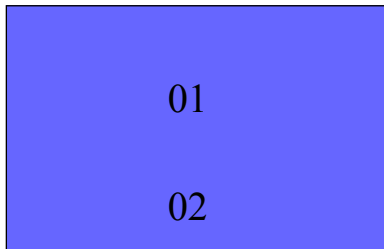

3 3 5

A

B.

C

1

2

3



" "



" ... "

" ... "

B

ESC

" "

3 3 6

		01/20
00	011	1234
01	013	2345

3 3 6

960M

0

1

20

5

100

" 0"

" 9999"

" -XXX"

$$XXX = - X*200+Y$$

Y 0-199

X 0-4

" 0" 13 14

" 1" 13 14

" 4"

1

0	-1	0	0	1	
1	10	100	10	0	100
2	10	100	100	10	
3	20	200	20	100	200
4	30	300	30	200	300
5	30	300	300	30	
6	50	0	50	300	0
7	0	0	0		

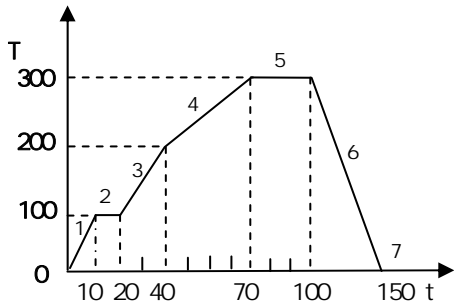

3

10



3

10

150

3

10



0

0

120

3 4

3 4

120

2

40	0	0	0		
41	10	100	10	0	100
42	10	200	10	100	200
43	20	200	200	20	
44	30	100	30	200	100
45	-42	100	42		
46	0	100	100		
47	10	200	10	100	200
48	-249	200	ON 13 14		
49	30	200	200	30	ON
50	10	250	10	200	250 ON

1



2

0



3

ESC

3



ESC

3 3 7

CH1 1/2	CH1 1/2
:	2:00:10-05:00
:04	3:05:10-07:00
1:00:10-05:00	4:07:10-10:00

3 3 7

A

0

B

10

C

n

24

0

U

FLASH

FLASH

U

U

4.1

1000D01. BI N 1000D02. BI N . . . 1000D04. BI N	1-4
1000PAR. BI N	
ALARM BI N	

4.2 FLASH

	FLASH	4000KB,			
	140	4	1	5600	
4					
		2 4			30
	1 4				8

$$T = \frac{1}{4}$$

$$T = 4000 * 504 / (1/1 + 1/5 + 1/10 + 1/20) = 1493333.3 = 414.8 = 17.28$$

4.3 U

U

U

U
U

U

FLASH

FLASH 4M

140 5600

U PC " U "

" U " PC

4.4 U

1 U

U PC U 2G U FAT 4G U FAT32

2 U

U USB

U " U "

U

U

U

U

U

U

U

3



U

4.4

U 1 U U U U
U FLASH U
2 U U U U
U U FLASH U
U U ESC U " ..."
U U U U
U

24

LU-R/C1000

— RS-232 RS-485

LU

Modbus

5.1 RS-232

RS-232

5

RS-232

RS-232

8 TXD 7 RXD

B1 GND

9

2 3 5

RS-232

5.1

RS-232

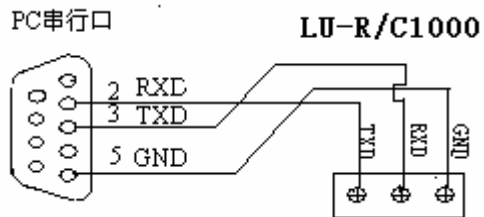

5.1 RS-232

5.2 RS-485

RS-485

1.5

RS-485

32

LU-R/C1000

RS-485

RS-232/485

8 A 7 B

5.2

1

120

RS-485

" + " " - "

2

" RS485"

RS-485

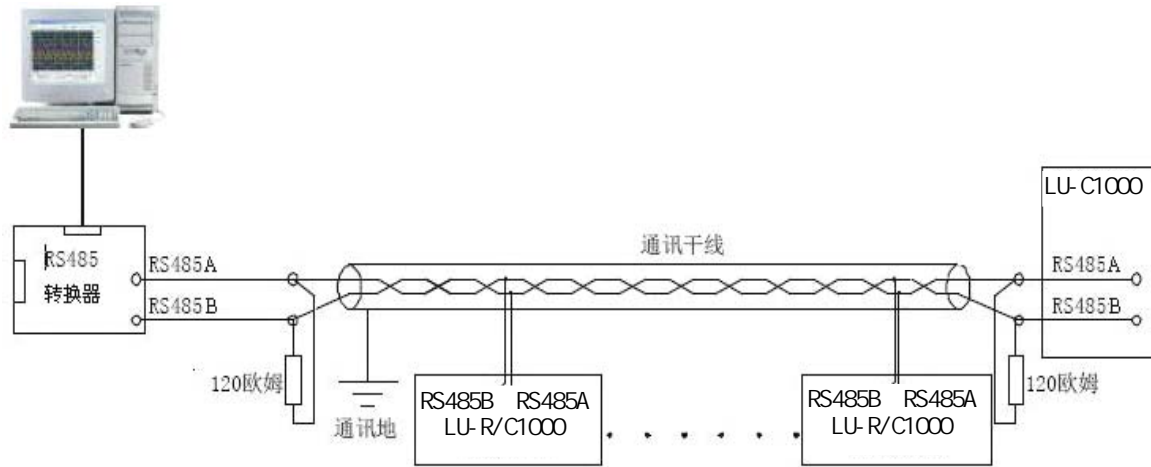

5.2 RS-485

